

A1200

monoblock full-range amplifier



OWNER'S MANUAL

*Thank you for purchasing a JL Audio amplifier for
your automotive sound system.*

*Your amplifier has been designed and manufactured to exacting
standards in order to ensure years of musical enjoyment in your vehicle.*

*For maximum performance and extended warranty
coverage, we highly recommend that you have your new amplifier
installed by an authorized JL Audio dealer. Your authorized
dealer has the training, expertise and installation equipment to ensure
optimum performance from this product. Should you
decide to install the amplifier yourself, please take the time
to read this manual thoroughly so as to familiarize yourself
with its installation requirements and setup procedures.*

*If you have any questions regarding the instructions in this
manual or any aspect of your amplifier's operation, please contact your
authorized JL Audio dealer for assistance. If you need further assistance,
please call the JL Audio Technical Support Department
at (954) 443-1100 during business hours.*



PROTECT YOUR HEARING!

We value you as a long-term customer. For that reason, we urge you to practice restraint in the operation of this product so as not to damage your hearing and that of others in your vehicle. Studies have shown that continuous exposure to high sound pressure levels can lead to permanent (irreparable) hearing loss. This and all other high-power amplifiers are capable of producing such high sound pressure levels when connected to a speaker system. Please limit your continuous exposure to high volume levels.

While driving, operate your audio system in a manner that still allows you to hear necessary noises to operate your vehicle safely (horns, sirens, etc.).

SERIAL NUMBER

In the event that your amplifier requires service or is ever stolen, you will need to have a record of the product's serial number. Please take the time to enter that number in the space provided below. The serial number can be found on the bottom panel of the amplifier and on the amplifier packaging.

Serial Number:

INSTALLATION APPLICATIONS

This amplifier is designed for operation in vehicles with 12 volt, negative-ground electrical systems. Use of this product in vehicles with positive ground and/or voltages other than 12V may result in damage to the product and will void the warranty.

This product is not certified or approved for use in aircraft.

Do not attempt to "bridge" the outputs of this amplifier with the outputs of a second amplifier, including an identical one.

PLANNING YOUR INSTALLATION

It is important that you take the time to read this manual and that you plan out your installation carefully. The following are some considerations that you must take into account when planning your installation.

Cooling Efficiency Considerations:

The outer shell of your JL Audio amplifier is designed to remove heat from the amplifier circuitry. For optimum cooling performance, this outer shell should be exposed to as large a volume of air as possible. Enclosing the amplifier in a small, poorly ventilated chamber can lead to excessive heat build-up and degraded performance. If an installation calls for an enclosure around the amplifier, we recommend that this enclosure be ventilated with the aid of a fan. In normal applications, fan-cooling is not necessary.

! IMPORTANT

Mounting the amplifier upside down is strongly discouraged.

If mounting the amplifier under a seat, make sure there is at least 1 inch (2.5 cm) of space above the amplifier's outer shell to permit proper cooling.

Safety Considerations:

Your amplifier needs to be installed in a dry, well-ventilated environment and in a manner which does not interfere with your vehicle's safety equipment (air bags, seat belt systems, ABS brake systems, etc.). You should also take the time to securely mount the amplifier using the supplied screws so that it does not come loose in the event of a collision or a sudden jolt to the vehicle.

Stupid Mistakes to Avoid

- Check before drilling any holes in your vehicle to make sure that you will not be drilling through a gas tank, brake line, wiring harness or other vital vehicle system.
- Do not run system wiring outside or underneath the vehicle. This is an extremely dangerous practice which can result in severe damage to your vehicle and person.
- Protect all system wires from sharp metal edges and wear by carefully routing them, tying them down and using grommets and loom where appropriate.
- Do not mount the amplifier in the engine compartment, under the vehicle, on the roof or in any other area that will expose the amplifier circuitry to the elements.

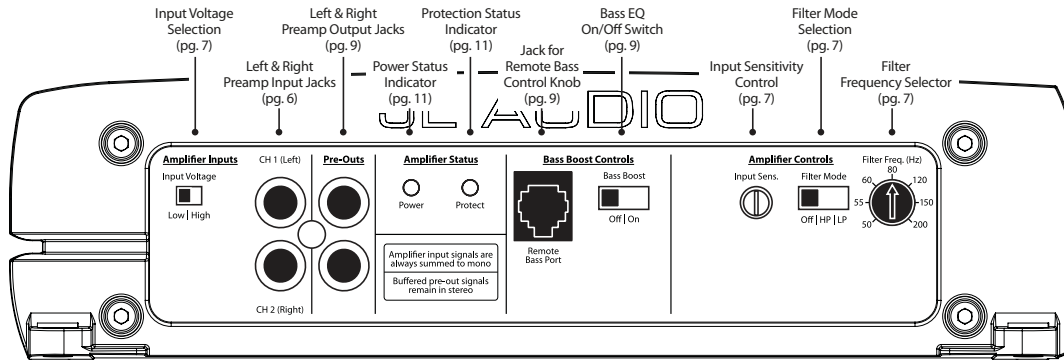
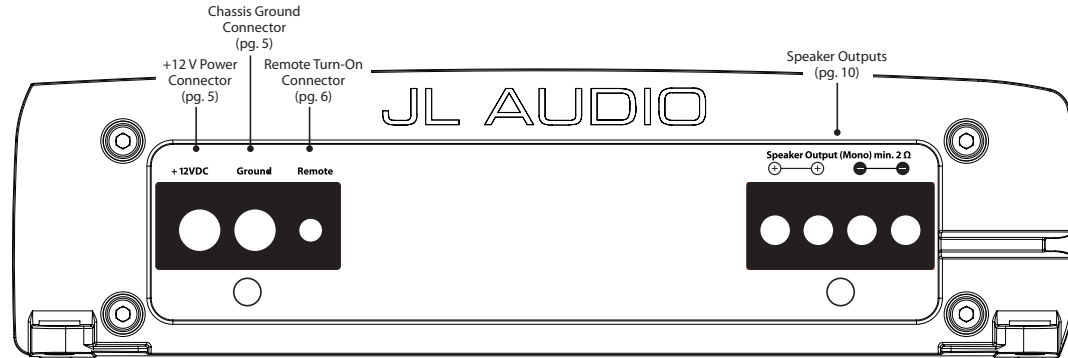

PRODUCT DESCRIPTION

The JL Audio A1200 is a monoblock, full-range amplifier utilizing patented Absolute Symmetry™ Class A/B technology.

The A1200 can be operated with a wide variety of source units and system configurations.

TYPICAL INSTALLATION SEQUENCE

The following represents the sequence for a typical amplifier installation, using an aftermarket source unit or OEM Interface processor (like the CleanSweep CL441dsp). Additional steps and different procedures may be required in some applications. If you have any questions, please contact your authorized JL Audio dealer for assistance.

- 1) Disconnect the negative battery post connection and secure the disconnected cable to prevent accidental re-connection during installation. **This step is not optional.**
- 2) Run power wire (minimum 8 AWG) from the battery location to the amplifier mounting location, taking care to route it in such a way that it will not be damaged and will not interfere with vehicle operation. Use 4 AWG or larger power wire and a power distribution block if additional amplifiers are being installed with the A1200.
- 3) Connect power wire to the positive battery post. Fuse the wire with an appropriate fuse block (and connectors) within 18 inches (45 cm) wire length of the positive battery post. **This fuse is essential to protect the vehicle. Do not install the fuse until the power wire has been securely connected to the amplifier.**
- 4) Run signal cables and remote turn-on wire from the source unit to the final amplifier mounting location.
- 5) Run speaker cables from the speaker systems to the amplifier mounting location.
- 6) Find a good, solid metal grounding point close to the amplifier and connect the negative power wire to it using appropriate hardware (use of the JL Audio ECS master ground lug, XA-MGL-1 is recommended). Use the same size power wire as the wire connected to the “+12VDC” connection (minimum 8 AWG), no longer than 36 inches (90 cm) from the amplifier to the ground connection point. In some vehicles, it may be necessary to upgrade the battery ground wire. (See page 5 for important notice).
- 7) Securely mount the amplifier using the supplied screws.
- 8) Connect the positive and negative power wires to the amplifier. A fuse near the amplifier is not necessary.
- 9) Connect the remote turn-on wire to the amplifier.
- 10) Connect the input cables to the amplifier.
- 11) Connect the speaker cables to the amplifier.
- 12) Carefully review the amplifier’s control settings to make sure that they are set according to the needs of the system.
- 13) Install the power wire fuse (25A for a single A1200) and reconnect the negative battery post terminal.
- 14) Turn on the source unit at a low level to double-check that the amplifier is configured correctly. Resist the temptation to crank it up until you have verified the control settings.
- 15) Make necessary adjustments to the input sensitivity controls to obtain the right overall output and the desired balance in the system. See Appendix A (page 12) for the recommended input sensitivity setting method.
- 16) Enjoy the fruits of your labor with your favorite music.

POWER CONNECTIONS

Before installing the amplifier, disconnect the negative (ground) wire from the vehicle’s battery. This will prevent accidental damage to the system, the vehicle and your body during installation.

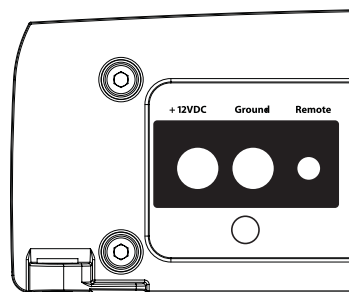

The A1200’s “+12VDC” and “Ground” connections are designed to accept 8 AWG - 4 AWG power wire. **8 AWG is a minimum power wire size for this amplifier.**

If you are installing the A1200 with other amplifiers and wish to use a single main power wire, use 4 AWG or larger main power wire (depending on the overall current demands of all the amplifiers in the system). This 4 AWG or larger power wire should terminate into a distribution block mounted as close to the amplifiers as possible and should connect to the A1200 with 8 AWG - 4 AWG power wire.

Note: that smaller AWG numbers mean bigger wire and vice-versa (1/0 AWG is the largest, 2 AWG is smaller, then 4 AWG, then 8 AWG, etc.).

To connect the power wires to the amplifier, first back out the set screw on the top of the terminal block, using the supplied 2.5 mm hex wrench. Strip 1/2 inch (12 mm) of insulation from the end of each wire and insert the bare wire into the terminal block, seating it firmly so that no bare wire is exposed. While holding the wire in place, tighten the set screw firmly, taking care not to strip the head of the screw.

The ground connection should be made using the same gauge wire as the power connection and should be kept as short as possible, while accessing a solid piece of sheet metal in the vehicle. The surface of the sheet metal should be sanded at the contact point to create a clean, metal-to-metal connection between the chassis and the termination of the ground wire. For optimal grounding, we recommend the use of a JL Audio ECS master ground lug (XA-MGL-1). Alternatively, a sheet metal screw or bolt can be used with a star washer.

Any wires run through metal barriers (such as firewalls), must be protected with a high quality rubber grommet to prevent damage to the insulation of the wire. Failure to do so may result in a dangerous short circuit.

! IMPORTANT

Many vehicles employ small (10 AWG - 6 AWG) wire to ground the battery to the vehicle chassis and to connect the alternator’s positive connection to the battery. To prevent voltage drops, these wires should be upgraded to 4 AWG when installing amplifier systems with main fuse ratings above 60A.

FUSE REQUIREMENTS

It is absolutely vital that the main power wire(s) to the amplifier(s) in the system be fused within 18 inches (45 cm) of the positive battery post connection. The fuse value at each power wire should be high enough for all of the equipment being run from that power wire. If only the A1200 is being run from that power wire, we recommend a 25A fuse be used. ANL (big blade fuse), AFS (small blade fuse), AGU (big glass fuse) or MaxiFuse™ (big plastic-body fuse) types are recommended.

No fuse is required or recommended directly before the amplifier power connection. If one is desired, we recommend the use of a 25A AGU, AFS or MaxiFuse™ type.

TURN-ON LEAD

The A1200 uses a conventional +12V remote turn-on lead, typically controlled by the source unit's remote turn-on output. The amplifier will turn on when +12V is present at its "Remote" input and turn off when +12V is switched off. If a source unit does not have a dedicated remote turn-on output, the amplifier's turn-on lead can be connected to +12V via a switch that derives power from an ignition-switched circuit.

The A1200's "Remote" turn-on connector is designed to accept 18 AWG – 12 AWG wire. To connect the remote turn-on wire to the amplifier, first back out the set screw on the top of the terminal block, using the supplied 2.5 mm hex wrench. Strip 1/2 inch (12mm) of wire and insert the bare wire into the terminal block, seating it firmly so that no bare wire is exposed. While holding the wire in the terminal, tighten the set screw firmly, taking care not to strip the head of the screw and making sure that the wire is firmly gripped by the set screw.

INPUT SECTION

The A1200's input section allows you to send signal to the amplifier section through the use of two differential-balanced inputs, one for the left channel signal and one for the right channel signal. Connection is via RCA-type jacks.

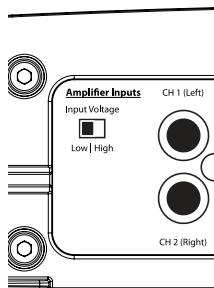

You may run a stereo or a mono signal into the inputs of the amplifier. The amplifier's input section automatically sums stereo signals to mono for the internal amplifier section.

The amplifier will operate with only one input connection (left or right), but will require an increase in input sensitivity to overcome the loss of signal. If a mono input signal is to be run, we recommend that you use a "Y-adaptor" to split the mono signal into both inputs of the amplifier.

Left Channel Only or Right Channel Only

Information: If you wish to send a Left-only or Right-only signal to the A1200, use a "Y-Adaptor" to split the single channel signal into both left and right RCA inputs. This option is useful when using one A1200 to drive the left channel speakers only and another A1200 to drive right channel speakers only.

! IMPORTANT

If you plan to use the "Pre-Outs" to feed a stereo amplifier, you must connect a stereo signal to the input of the amplifier. A mono signal into the amplifier will result in a mono signal out of the preamp output. (It's a great amplifier, but it doesn't do magic).

INPUT VOLTAGE RANGE:

A wide range of signal input voltages can be accommodated by the A1200's input section (200mV – 8V). This wide range is split up into two sub-ranges, accessible via a switch located to the left of the Input Connectors.

The "Low" position on the "Input Voltage" switch selects an input sensitivity range between 200mV and 2V. This means that the "Input Sens." rotary control will operate within that voltage window. If you are using an aftermarket source unit or an OEM interface processor with conventional preamp-level outputs, this is most likely the position that you will use.

The "High" position on the "Input Voltage" switch selects an input sensitivity range between 800mV and 8V. This is useful for certain high-output preamp level signals as well as speaker-level output from source units and small amplifiers.

To use speaker-level sources, splice the speaker output wires of the source unit or small amplifier onto a pair of RCA plugs. No line output converter is needed in most cases.

! IMPORTANT

The output of the amplifier will decrease for a given input voltage when the "Input Range" switch is placed in the "High" position. Conversely, the output will be higher with the switch in the "Low" position. While this may sound counter-intuitive, it is consistent with the descriptions above.

AMPLIFIER CONTROLS

1) "Input Sens.": Once the appropriate "Input Voltage" range has been selected, the control labeled "Input Sens." located in the "Amplifier Controls" section can be used to match the source unit's output voltage to the input stage of the amplifier for maximum clean output. Rotating the control clockwise will result in higher sensitivity (louder for a given input voltage). Rotating the control counter-clockwise will result in lower sensitivity (quieter for a given input voltage.)

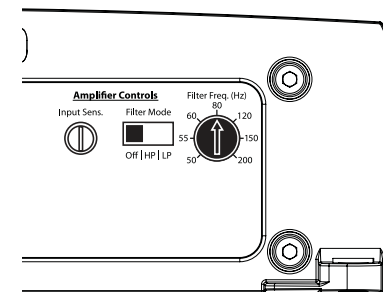

To properly set the amplifier for maximum clean output, please refer to Appendix A (page 12). After using this procedure, you can then adjust the "Input Sens." level downward if this is required to achieve the desired system balance.

Do not increase any "Input Sens." setting for any channel(s) of any amplifier in the system beyond the maximum level established during the procedure outlined in Appendix A (page 12). Doing so will result in audible distortion and possible speaker damage.

Filter Controls

Most speakers are not designed to reproduce the full range of frequencies audible by the human ear. For this reason, most speaker systems are comprised of multiple speakers, each dedicated to reproducing a specific frequency range. Filters are used to select which frequency range is sent to each section of a speaker system. The division of frequency ranges to different speakers can be done with passive filters (coils and/or capacitors between the amplifier outputs and the speakers), which are acceptable and commonly used for filtering between mid-range speakers and tweeters. Filtering between subwoofer systems and satellite speaker systems is best done with active filters, which cut off frequency content at the input to the amplifier. Active filters are more stable than passive filters and do not introduce extraneous resistance, which can degrade subwoofer performance.

The active filter built into the A1200 can be used to eliminate potentially harmful and/or undesired frequencies from making their way through the amplifier section to the speaker(s). This serves to improve tonal balance and to avoid distortion and possible speaker failure. Correct use of this filter can substantially increase the longevity and fidelity of your audio system.

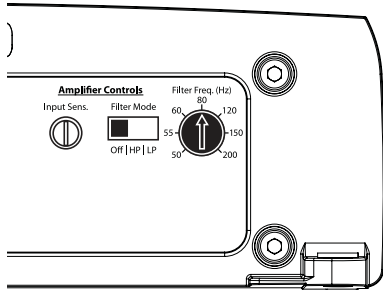

2) **“Filter Mode” Control:** The A1200 employs a 12dB per octave filter. This filter can be configured into one of two filter types or defeated completely by way of the three-position **“Filter Mode”** switch:

“Off”: Defeats the filter completely, allowing the full range of frequencies present at the inputs to feed the amplifier. This is useful for systems utilizing outboard crossovers or requiring full-range reproduction from the A1200.

“LP” (Low-Pass): Configures the filter to attenuate frequencies above the selected filter frequency at a rate of 12dB per octave. Useful for connection of subwoofer(s) to the A1200 in a bi-amplified system.

“HP” (High-Pass): Configures the filter to attenuate frequencies below the selected filter frequency at a rate of 12dB per octave. Useful for connection of a coaxial or component satellite speaker system to the A1200 in a bi-amplified system.

3) **“Filter Freq. (Hz)”** The filter frequency markings surrounding this rotary control are for reference purposes and are generally accurate to within 1/3 octave or better. If you would like to select the filter cutoff frequency with a higher level of precision, consult the chart in Appendix B (page 13).

Tuning Hint: If you are using the A1200 to drive a subwoofer system (“LP” mode) or a component satellite speaker system (“HP” mode), 80 Hz is a good baseline **“Filter Freq. (Hz)”** setting. After properly adjusting the **“Input Sens.”**, as outlined in Appendix A (page 12), you can fine tune the **“Filter Freq. (Hz)”** control to achieve the desired system frequency response.

BASS BOOST CONTROLS

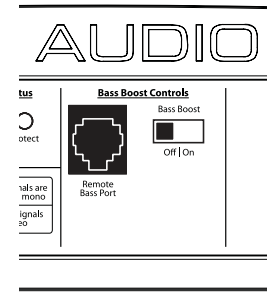

- 1) **“Bass Boost”:** This switch allows the user to activate a 6 dB boost centered at 48 Hz. The **“Filter Mode”** switch in the **“Amplifier Controls”** section must be in the **“LP”** position for the bass boost to be functional.
- 2) **“Remote Bass Port”:** This port allows you to connect an optional remote boost knob (sold separately, JL Audio Model RBC-1) that can be mounted in the front of the vehicle. With the RBC-1 connected, the boost is no longer limited to 0 or +6 dB, allowing a range of 0 - 12 dB of boost to be selected.

PRE-OUTS

The A1200’s **“Pre-Outs”** connectors output unprocessed (pass-through) left and right channel preamp level signals, permitting connection of additional amplifiers in a system.

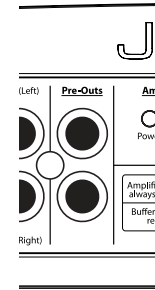

The preamp output signals are identical to the input signals and are not affected by any settings in the **“Amplifier Controls”** or **“Bass Boost Controls”** sections. The signal level of the **“Preamp Output”** is line-level (low voltage), regardless of the position selected via the A1200’s **“Input Voltage”** switch. An additional amplifier connected to these preamp outputs should have its input voltage switch set to the **“Low”** position.

SPEAKER OUTPUTS

The A1200's speaker outputs are designed to accept 8 AWG - 16 AWG wire.

The A1200 is designed to deliver power into speaker loads equal to or greater than 2 ohms.

To connect the speaker wires to the amplifier, first back out the set screws on the top of the terminal block, using the supplied 2.5 mm hex wrench. Strip 1/2 inch (12 mm) of insulation from the end of each wire and insert the bare wire into the terminal block, seating it firmly so that no bare wire is exposed. While holding the wire in place, tighten the set screw firmly, taking care not to strip the head of the screw.

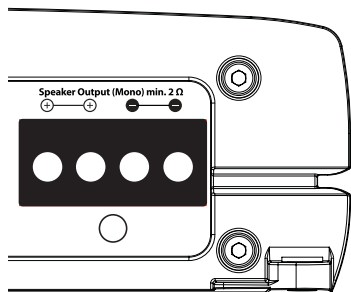

! IMPORTANT

Speaker loads below 2 ohms nominal are not recommended and may cause the amplifier to initiate a protection mode which reduces power output.

You will notice that there are two “+” positive connections and two “-” negative connections. This is to facilitate multiple speaker wiring. The two positive and two negative connections are connected in parallel inside the amplifier. Connecting two speakers, each to one set of positive and negative terminals, will result in a parallel speaker connection. If only connecting one pair of speaker wires, it is not necessary to use both sets of connections.

! IMPORTANT

Do not attempt to “bridge” the outputs of this amplifier with the outputs of a second amplifier, including an identical one.

AMPLIFIER STATUS INDICATOR LIGHTS & PROTECTION CIRCUITRY

There are two status indicator lights on the input / control end of the amplifier.

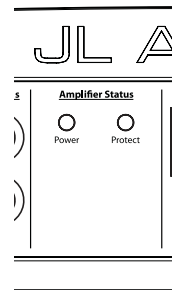

- 1) **“Power” (Green):** lights to indicate that the amplifier is turned on and operating normally.
- 2) **“Protect” (Red):** Indicates that the amplifier protection circuitry has been activated to prevent product failure due to a short-circuit or a dangerously low impedance connected to the amplifier output(s). Connecting the speaker outputs to an impedance lower than 2 ohms stereo (4 ohms bridged) will cause this protection mode to activate. When this protection mode is activated, the amplifier will reduce its maximum power output to protect its circuitry, which will manifest itself as increased distortion. When the problem is corrected, the amplifier will return to normal operation.

Advanced Rollback Thermal protection

Unlike conventional thermal protection systems, which shut down an amplifier when it overheats, this system protects the amplifier by gradually reducing power output if the amplifier's safe operating temperature is exceeded. The amplifier will continue to operate and return to normal power output once its temperature returns to a normal range.

Low-Voltage protection:

If the car's supply voltage drops below 10 volts, the entire amplifier will shut itself off to protect its internal circuitry. The green “Power” indicator will turn off when this occurs. The amplifier will turn back on when voltage climbs back above 10 volts. This may happen in a rapid cycle when bass-heavy program material causes a weak charging system to dip below 10 volts momentarily. If this is happening in your system, turn your audio system off and have your power wiring, ground connections and charging system inspected.

SERVICING YOUR JL AUDIO AMPLIFIER

If your amplifier fails or malfunctions, please return it to your authorized JL Audio dealer so that it may be sent in to JL Audio for service. There are no user serviceable parts or fuses inside the amplifier. The unique nature of the circuitry in the JL Audio amplifiers requires specifically trained service personnel. Do not attempt to service the amplifier yourself or through unauthorized repair facilities. This will not only void the warranty, but may result in the creation of more problems within the amplifier.

If you have any questions about the installation or setup of the amplifier not covered in this manual, please contact your dealer or technical support.

JL Audio Technical Support:

(954) 443-1100

9:00 AM – 5:30 PM (Eastern Time Zone)

Monday - Friday

APPENDIX A:

Input Sensitivity Level Setting

Following the directions below will allow the installer to adjust the input sensitivity of each amplifier channel pair simply and easily in just a few minutes using equipment which is commonly available in installation bays.

Necessary Equipment

- Digital AC Voltmeter
- CD with a sine-wave test tone recorded at 0 dB reference level in the frequency range to be amplified for that set of channels (50 Hz for subwoofer channels, 1 kHz for a midrange application). Do not use attenuated test tones (-10 dB, -20 dB, etc.).

The Nine-Step Procedure

- 1) Disconnect the speaker(s) from the amplifier's speaker output connectors.
- 2) Turn off all processing (bass/treble, loudness, EQ, etc.) on the source unit, processors (if used) and amplifier. Set fader control to center position and subwoofer level control to 3/4 of maximum (if used to feed the A1200).
- 3) Switch the "Input Voltage" switch to "Low" and turn the "Input Sens." control all the way down.
- 4) Set the source unit volume to 3/4 of full volume. This will allow for reasonable gain overlap with moderate clipping at full volume.
- 5) Using the chart on this page, determine the target voltage for input sensitivity adjustment according to the nominal impedance of the speaker system connected to the amplifier outputs.
- 6) Verify that you have disconnected the speakers before proceeding. Play a track with an appropriate sine wave (within the frequency range to be amplified by the A1200) at 3/4 source unit volume.
- 7) Connect the AC voltmeter to the speaker output connectors of the amplifier. Make sure you test the voltage at the correct connectors (+ and -).

- 8) Increase the "Input Sens." control until the target voltage is observed with the voltmeter.
- 9) Once you have adjusted the A1200 to its maximum low-distortion output level, reconnect the speaker(s). The "Input Sens." controls can now be adjusted downward if the amplifier requires attenuation to achieve the desired system balance.

! IMPORTANT

Do not increase any "Input Sens." setting for any amplifier channel or channel pair in the system beyond the maximum level established during this procedure. Doing so will result in audible distortion and possible speaker damage.

It will be necessary to re-adjust the "Input Sens." for the affected channels if any equalizer boost is activated after setting the "Input Sens." with this procedure. This applies to any EQ boost circuit, including source unit tone controls or EQ circuits. EQ cuts will not require re-adjustment.

Nom. Impedance	Target AC Voltage
4Ω	21.9 V
3Ω	21.0 V
2Ω	20.0 V

APPENDIX B:

Precise Frequency Selection Chart

Detent Number	"FILTER FREQ" AMP FILTER Panel Marking	Actual Freq.
Full counter-clockwise: 53		
01		53
02	"50"	53
03		53
04		54
05		54
06		55
07		55
08	"55"	56
09		56
10		57
11		58
12		59
13		62
14	"60"	65
15		65
16		66
17		70
18		73
19		77
20	"80"	81
21		84
22		88
23		94
24		101
25		104
26	"120"	115
27		118
28		128
29		137
30		146
31		164
32	"150"	177
33		193
34		197
35		209
36		213
37		216
38	"200"	218
39		225

Full-clockwise: 225

APPENDIX C:

A1200 Specifications

General Specifications:

Recommended Fuse Value: 25A

Recommended Fuse Type: AGU, AFS or MaxiFuse™

Input Sections:

No. of Inputs: One Stereo Pair

Input Type: Differential-balanced with RCA jack inputs

Input Range: Switchable from 200mV - 2V RMS to 800mV - 8V RMS

Amplifier Section:

Amplifier Topology: Class A/B with patented Absolute Symmetry™ dual N-Channel MOSFET output design

Power Supply: Unregulated MOSFET switching type

Rated Power at 12.5V with less than

0.08% THD+Noise (20Hz - 2 kHz):

120W RMS x 1 @ 4 ohms, 200W RMS x 1 @ 2 ohms

Rated Power @ 14.4V with less than

1% THD + Noise (20Hz - 20 kHz):

175W RMS x 1 @ 4 ohms, 275W RMS x 1 @ 2 ohms

Signal to Noise Ratio: >104 dB referred to rated power (A-weighted, 20 Hz-20 kHz noise bandwidth)

Frequency Response: 10 Hz - 25 kHz (+0, -1dB)

Damping Factor: >200 @ 4 ohms/50 Hz,

>100 @ 2 ohms/50 Hz

Slew Rate: ± 22V/μs

Amplifier Filter:

Filter Type: State-variable, 12dB/octave Butterworth with continuously variable cutoff frequency selection from 50-200 Hz. Configurable as Low-Pass or High-Pass. Defeatable.

Preamp Output:

Buffered pass-through type.

Dimensions(LxWxH):

9.8" x 9.25" x 2.50" (250mm x 235mm x 63.5mm)

Due to ongoing product development, all specifications are subject to change without notice.

APPENDIX D: TROUBLE SHOOTING

“How do I properly set the input sensitivity on my amplifier”

Please refer to Appendix A (page 12) to set the input sensitivity for maximum, low-distortion output.

“My amplifier doesn’t turn on”

Check the fuse, not just visually, but with a continuity meter. It is possible for a fuse to have poor internal connections that cannot be found by visual inspection. It is best to take the fuse out of the holder for testing. If no problem is found with the fuse, inspect the fuse-holder.

Check the integrity of the connections made to each of the “+12VDC”, “Ground”, and “Remote” terminals. Ensure that no wire insulation is pinched by the terminal set screw and that each connection is tight.

Check to make sure there is +12V at the “Remote” connection of the amplifier. In some cases, the turn-on lead from the source unit is insufficient to turn on multiple devices and the use of a relay is required. To test for this problem, jump the “+12VDC” wire to the “Remote” terminal to see if the amplifier turns on. If this does not work, proceed to the next step.

“I get a distorted / attenuated sound coming out of the speaker(s)”

Check the speaker wires for a possible short, either between the positive and negative leads or between either speaker lead and the vehicle’s chassis ground. If a short is present, you will experience distorted and/or attenuated output. The “Protect” light will illuminate in this situation. It may be helpful to disconnect the speaker wires from the amplifier and use a different set of wires connected to a test speaker.

Check the nominal load impedance to verify that of the amplifier is driving a load equal to or greater than 2 ohms.

Check the input signal and input signal cables to make sure signal is present at the “Amplifier Inputs” and the cables are not pinched or loose. It may be helpful to try a different set of cables and/or a different signal source to be sure.

“My amplifier’s output fluctuates when I tap on it or hit a bump”

Check the connections to the amplifier. Make sure that the insulation for all wires has been stripped back far enough to allow a good contact area inside the terminal block.

Check the input connectors to ensure that they all are making good contact with the input jacks on the amplifier.

“My amplifier shuts off once in a while, usually at higher volumes”

Check your voltage source and grounding point. The power supply of the A1200 will operate with charging system voltages down to 10V. Shutdown problems at higher volume levels can occur when the charging system voltage drops below 10V. These dips can be of very short duration making them extremely difficult to detect with a common DC voltmeter. To ensure proper voltage, inspect all wiring and termination points. It may also be necessary to upgrade the ground wire connecting the battery to the vehicle’s chassis and the power wire connecting the alternator to the battery. Many vehicles employ small (10 AWG - 6 AWG) wire to ground the battery to the vehicle’s chassis and to connect the alternator to the battery. To prevent voltage drops, these wires should be upgraded to 4 AWG when installing amplifier systems with main fuse ratings above 60A. Grounding problems are the leading cause of misdiagnosed amplifier “failures.”

“My amplifier turns on, but there is no output”

Check the input signal using an AC voltmeter to measure the voltage from the source unit while an appropriate test tone is played through the source unit (disconnect the input cables from the amplifier prior to this test). The frequency used should be in the range that is to be amplified by the amplifier (example: 50 Hz for a sub bass application or 1 kHz for a full range / high-pass application). A steady, sufficient voltage (between 0.2 and 8.0-volts) should be present at the output of the signal cables.

Check the output of the amplifier. Using the procedure explained in the previous check item (after plugging the input cables back into the amplifier) test for output at the speaker outputs of the amplifier. Unless you enjoy test tones at high levels, it is a good idea to remove the speaker wires from the amplifier while doing this. Turn the volume up approximately half way. 5V or more should be measured at the speaker outputs. This output level can vary greatly between amplifiers but it should not be in the millivolt range with the source unit at half volume. If you are reading sufficient voltage, check your speaker connections as explained below.

Check to ensure that the speaker wires are making a good connection with the metal inside the terminal block. The speaker wire connectors are designed to accept up to 8 AWG wire. Make sure to strip the wire to allow for a sufficient connection with the metal inside the terminal block.

INSTALLATION NOTES:

Use this diagram to document your amplifier's switch and control positions.

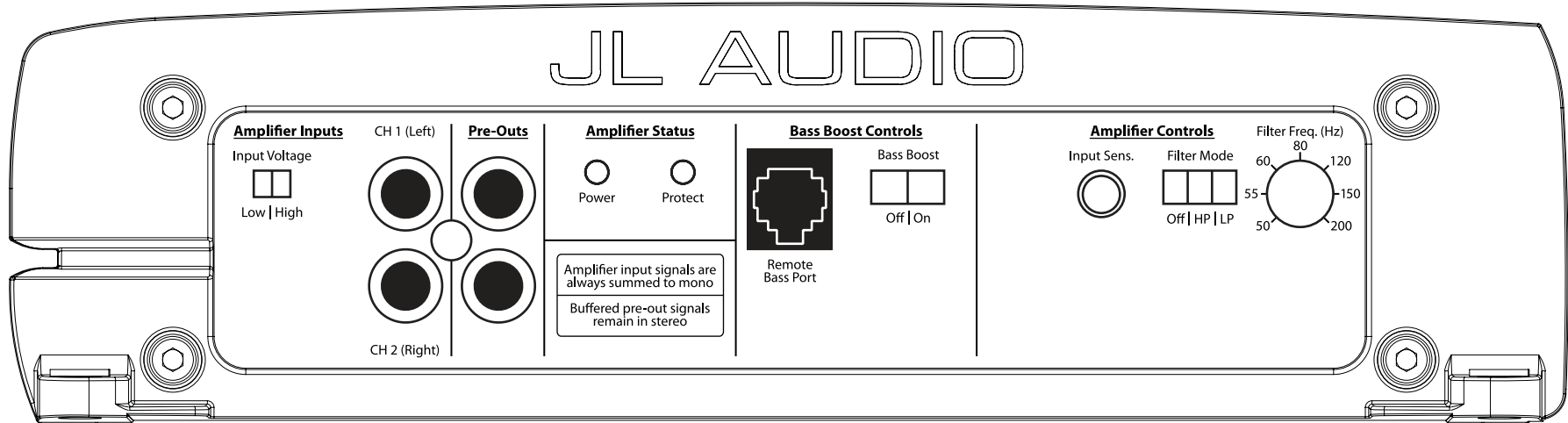

INSTALLATION NOTES:

INSTALLATION NOTES:

LIMITED WARRANTY - AMPLIFIERS (USA)

JL AUDIO warrants this product to be free of defects in materials and workmanship for a period of ninety (90) days from the original date of purchase. The warranty term is extended to two (2) years if installation is performed or approved by an authorized JL AUDIO dealer (proof of installation or approval required on purchase receipt).

This warranty is not transferrable and applies only to the original purchaser from an authorized JL AUDIO dealer. Should service be necessary under this warranty for any reason due to manufacturing defect or malfunction, JL AUDIO will (at its discretion), repair or replace the defective product with new or remanufactured product at no charge. Damage caused by the following is not covered under warranty: accident, misuse, abuse, product modification or neglect, failure to follow installation instructions, unauthorized repair attempts, misrepresentations by the seller. This warranty does not cover incidental or consequential damages and does not cover the cost of removing or reinstalling the unit(s). Cosmetic damage due to accident or normal wear and tear is not covered under warranty.

Warranty is void if the product's serial number has been removed or defaced.

Any applicable implied warranties are limited in duration to the period of the express warranty as provided herein beginning with the date of the original purchase at retail, and no warranties, whether express or implied, shall apply to this product thereafter. Some states do not allow limitations on implied warranties, therefore these exclusions may not apply to you. This warranty gives you specific legal rights, and you may also have other rights which vary from state to state.

If you need service on your JL AUDIO product:

All warranty returns should be sent to JL AUDIO 's Amplifier Service Facility freight-prepaid through an authorized JL AUDIO dealer and must be accompanied by proof of purchase (a copy of the original sales receipt). Direct returns from consumers or non-authorized dealers will be refused unless specifically authorized by JL AUDIO with a valid return authorization number.

Warranty expiration on products returned without proof of purchase will be determined from the manufacturing date code. Coverage may be invalidated as this date is previous to purchase date. Non-defective items received will be returned freight-collect. Customer is responsible for shipping charges and insurance in sending the product to JL AUDIO. Freight damage on returns is not covered under warranty.

For Service Information in the U.S.A. please call

JL Audio Customer Service: (954) 443-1100

9:00 AM – 5:30 PM (Eastern Time Zone)

JL Audio, Inc

10369 North Commerce Pkwy.

Miramar, FL 33025

(do not send product for repair to this address)

International Warranties:

Products purchased outside the United States of America are covered only by that country's distributor and not by JL Audio, Inc.

Absolute Symmetry™ Class A/B Amplifier Circuit is covered by U.S. Patent #6,294,959 and is pending in the countries listed below. Austria, Belgium, Brazil, Canada, China, France, Germany, Indonesia, Italy, Japan, Republic of Korea, Mexico, Netherlands, Norway, Russian Federation, Singapore, Sweden, Switzerland, United Kingdom, and all other PCT countries.