



JL AUDIO 500/1
monoblock subwoofer amplifier

owner's manual

*Thank you for purchasing a JL Audio amplifier for
your automotive sound system.*

Your amplifier has been designed and manufactured to exacting standards in order to ensure years of musical enjoyment in your vehicle. For maximum performance and extended warranty coverage, we highly recommend that you have your new amplifier installed by an authorized JL Audio dealer. Your authorized dealer has the training, expertise and installation equipment to ensure optimum performance from this product. Should you decide to install the amplifier yourself, please take the time to read this manual thoroughly so as to familiarize yourself with its installation requirements and setup procedures.

If you have any questions regarding the instructions in this manual or any aspect of your amplifier's operation, please contact your authorized JL Audio dealer for assistance. If you need further assistance, please call the JL Audio Technical Support Department at (954) 443-1100 during business hours (Eastern Time Zone).



PROTECT YOUR HEARING!

We value you as a long-term customer. For that reason, we urge you to practice restraint in the operation of this product so as not to damage your hearing and that of others in your vehicle. Studies have shown that continuous exposure to high sound pressure levels can lead to permanent (irreparable) hearing loss. This and all other high-power amplifiers are capable of producing such high sound pressure levels when connected to a speaker system. Please limit your continuous exposure to high volume levels.

While driving, operate your audio system in a manner that still allows you to hear necessary noises to operate your vehicle safely (horns, sirens, etc.).

SERIAL NUMBER

In the event that your amplifier requires service or is ever stolen, you will need to have a record of the product's serial number. Please take the time to enter that number in the space provided below. The serial number can be found on the bottom panel of the amplifier and on the amplifier packaging.

Serial Number:

INSTALLATION APPLICATIONS

This amplifier is designed for operation in vehicles with 12V, negative-ground electrical systems. Use of this product in vehicles with positive ground and/or voltages other than 12V may result in damage to the product and will void the warranty.

This product is **not** certified or approved for use in aircraft.

Do not attempt to "bridge" the outputs of this amplifier with the outputs of a second amplifier; including an identical one.

PLANNING YOUR INSTALLATION

It is important that you take the time to read this manual and that you plan out your installation carefully. The following are some considerations that you must take into account when planning your installation.

Cooling Efficiency Considerations:

Your JL Audio amplifier employs an advanced type of heat management, called RealSink™. This feature takes advantage of convection and radiation effects to remove heat from the amplifier circuitry. For optimum cooling performance, the vertical heat sinks located at the back of the amplifier should be exposed to as large a volume of air as possible. Enclosing the amplifier in a small, poorly ventilated chamber can lead to excessive heat build-up and degraded performance. If an installation calls for an enclosure around the amplifier; we recommend that this enclosure be ventilated with the aid of a fan. In normal applications, fan-cooling is not necessary, but you still need to follow some basic guidelines:

- Amplifier mounted vertically with heat sink fins pointing up: Optimum
- Amplifier mounted horizontally, right side up: Good
- Amplifier mounted horizontally, but upside down: Fair (not recommended if there is less than 1 inch (2.5 cm) clearance above the amplifier heat sinks)
- Amplifier mounted vertically with heat sink fins pointing laterally: Fair
- Amplifier mounted vertically with heat sink fins pointing down: Poor (not recommended)

If mounting the amplifier under a seat, make sure there is at least 1 inch (2.5 cm) of space above the amplifier heat sink fins to permit proper cooling.

Safety Considerations:

Your amplifier needs to be installed in a dry, well-ventilated environment and in a manner which does not interfere with your vehicle's safety equipment (air bags, seat belt systems, ABS brake systems, etc.). You should also take the time to securely mount the amplifier using the supplied screws so that it does not come loose in the event of a collision or a sudden jolt to the vehicle (15 lbs. of aluminum traveling at 60 MPH will hurt you).

Stupid Mistakes to Avoid:

- Check before drilling any holes in your vehicle to make sure that you will not be drilling through a gas tank, brake line, wiring harness or other vital vehicle system.
- Do not run system wiring outside or underneath the vehicle. This is an extremely dangerous practice which can result in severe damage to your vehicle and person.
- Protect all system wires from sharp metal edges and wear by carefully routing them, tying them down and using grommets and loom where appropriate.
- Do not mount the amplifier in the engine compartment, under the vehicle, on the roof or in any other area that will expose the amplifier circuitry to the elements.

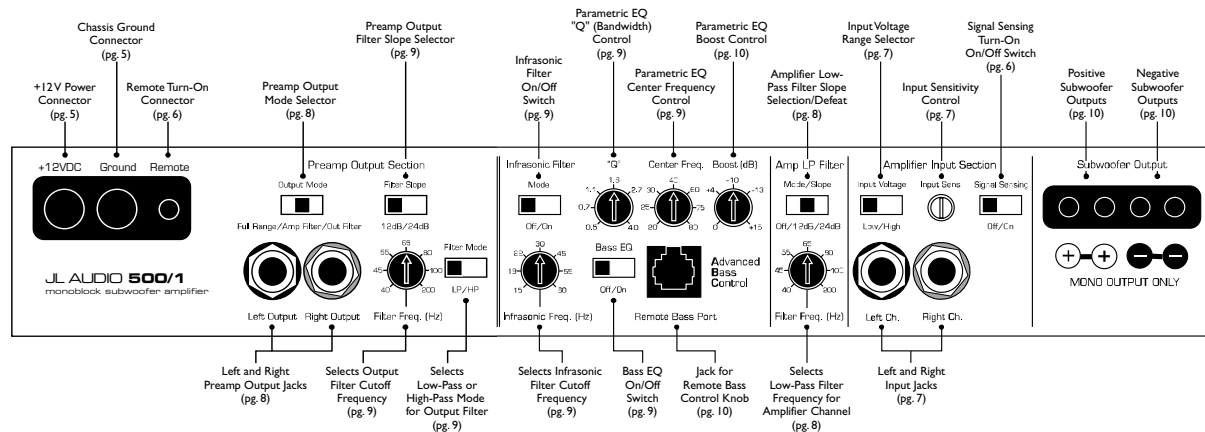

PRODUCT DESCRIPTION

The JL Audio 500/1 is a monoblock subwoofer amplifier utilizing proprietary and patented Class D technology. Its frequency response is limited to the range below 250 Hz. It is not designed for driving midrange speakers or tweeters. Every aspect of its operation has been optimized for low-frequency amplification. For detailed specifications, please refer to Appendix E (page 21).

TYPICAL INSTALLATION SEQUENCE

The following represents the sequence for a typical amplifier installation, using an aftermarket source unit. Additional steps and different procedures may be required in some applications. If you have any questions, please contact your authorized JL Audio dealer for assistance.

1) Disconnect the negative battery post connection and secure the disconnected cable to prevent accidental re-connection during installation.

This step is not optional!

2) Run power wire (minimum 8 AWG) from the battery location to the amplifier mounting location, taking care to route it in such a way that it will not be damaged and will not interfere with vehicle operation. Use 4 AWG, 2 AWG or 1/0 AWG power wire if additional amplifiers are being installed with the 500/1.

3) Connect power wire to the positive battery post. Fuse the wire with an appropriate fuse block (and connectors) within 18 inches (45 cm) wire length of the positive battery post. **This fuse is essential to protect the vehicle. Do not install the fuse until the power wire has been connected to the amplifier.**

4) Run signal cables (RCA cables) and remote turn-on wire from the source unit to the amplifier mounting location.

5) Run speaker wire from the speaker system to the amplifier mounting location.

6) Find a good, solid metal grounding point close to the amplifier and connect the negative power wire to it using appropriate hardware. Use the same size power wire as the wire connected to the “+12V” connection (min. 8 AWG), no longer than 36 inches (90 cm) from the amplifier to the ground connection point. In some vehicles, it may be necessary to upgrade the battery ground wire. (See page 5 for important notice).

7) Securely mount the amplifier using the supplied screws.

8) Connect the positive and negative power wires to the amplifier. A fuse near the amplifier is not necessary.

9) Connect the remote turn-on wire to the amplifier:

10) Connect the RCA input cables to the amplifier:

11) Connect the speaker wires to the amplifier:

12) Carefully review the amplifier's control settings to make sure that they are set according to the needs of the system.

13) Install power wire fuse (50A for a single 500/1) and reconnect the negative battery post terminal.

14) Turn on the source unit at a low level to double-check that the amplifier is configured correctly. Resist the temptation to crank it up until you have verified the control settings.

15) Make necessary adjustments to the input sensitivity control to obtain the right overall output and the desired balance between the subwoofer output and the satellite (mid and high-frequency) output. See Appendix B (page 14) for the recommended input sensitivity setting method.

16) Enjoy the fruits of your labor with your favorite music.

POWER CONNECTIONS

Before installing the amplifier, disconnect the negative (ground) wire from the vehicle's battery. This will prevent accidental damage to the system, the vehicle and your person during installation.

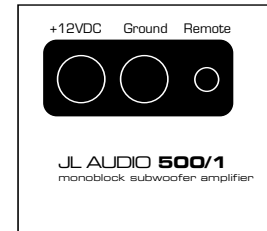

The 500/1's “+12VDC” and “Ground” connections are designed to accept 8 AWG - 4 AWG power wire. **8 AWG is a minimum power wire size for this amplifier.**

If you are installing the 500/1 with other amplifiers and wish to use a single main power wire, use 4 AWG, 2 AWG or 1/0 AWG main power wire (depending on the overall current demands of all the amplifiers in the system). This 4 AWG, 2 AWG or 1/0 AWG power wire should terminate into a distribution block mounted as close to the amplifiers as possible and should connect to the 500/1 with 8 AWG or 4 AWG power wire.

Please note that smaller AWG numbers mean bigger wire and vice-versa (1/0 AWG is biggest, 2 AWG is smaller, then 4 AWG, then 8 AWG, etc.).

To connect the power wires to the amplifier, first back out the set screw on the top of the amplifier, using the supplied 2.5 mm hex wrench. Strip 1/2 inch (12 mm) of insulation from the end of each wire and insert the bare wire into the receptacle on the front panel of the amplifier, seating it firmly so that no bare wire is exposed. While holding the wire in place, tighten the set screw firmly, taking care not to strip the head of the screw.

The ground connection should be made using the same gauge wire as the power connection and should be kept as short as possible, while accessing a solid piece of sheet metal in the vehicle. The surface of the sheet metal should be sanded at the contact point to create a clean, metal-to-metal connection between the chassis and the termination of the ground wire. The use of a star washer to lock down the connection is advisable.

Any wires run through metal barriers (such as firewalls), must be protected with a high quality rubber grommet to prevent damage to the insulation of the wire. Failure to do so may result in a dangerous short circuit.

! IMPORTANT

Many vehicles employ small (10 AWG - 6 AWG) wire to ground the battery to the vehicle chassis and to connect the alternator's positive connection to the battery. To prevent voltage drops, these wires should be upgraded to 4 AWG (or larger) when installing amplifier systems with total fuse ratings exceeding 60A.

FUSE REQUIREMENTS

It is absolutely vital that the main power lead to the amplifier(s) in the system be fused within 18 inches (45 cm) of the positive battery post connection. The fuse value at each power wire should be high enough for all of the equipment being run from that power wire. If only the 500/1 is being run from that power wire, we recommend a 50A fuse be used. AGU (big glass fuse) or MaxiFuse™ (big plastic-body fuse) types are recommended.

No fuse is required directly before the amplifier power connection. If one is desired, we recommend the use of a 50A AGU fuse or MaxiFuse™ type.

TURN-ON OPTIONS

The 500/1 can be turned on and off using two different methods:

- 1) A conventional +12V remote turn-on lead.
- 2) A signal sensing turn-on circuit.

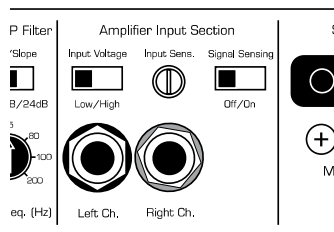

To select between the two modes there is a switch, marked “Signal Sensing”, located in the “Amplifier Input Section” of the front panel.

1) **Conventional Remote Turn-On Method:** uses a conventional +12V remote turn-on lead, typically controlled by the source unit’s remote turn-on output. The amplifier will turn on when +12V is present at its “Remote” input and turn off when +12V is switched off. If a source unit does not have a dedicated remote turn-on output, the amplifier’s turn-on lead can be connected to +12V via a switch that derives power from an ignition-switched circuit. To use this method, select “Off” on the “Signal Sensing” switch in the “Amplifier Input Section”.

The 500/1’s “Remote” turn-on connector is designed to accept 12 AWG – 8 AWG wire. 12 AWG is more than adequate for this purpose. To connect the remote turn-on wire to the amplifier, first back out the set screw on the top of the amplifier, using the supplied hex wrench. Strip 1/2 inch (12mm) of wire and insert the bare wire into the receptacle on the front panel of the amplifier, seating it firmly so that no bare wire is exposed. Smaller wire than 12 AWG can be used, but it may be necessary to strip 1 inch of insulation from the wire and fold the bare wire in half prior to insertion. While holding the wire in the terminal, tighten the set screw firmly, taking care not to strip the head of the screw and making sure that the wire is firmly gripped by the set screw.

2) **Signal Sensing Turn-On Method:** A valuable feature of the 500/1 is its ability to be turned on and off by the presence or lack of signal at its audio inputs. This allows you to operate the amplifier without having to locate a remote turn-on lead at the source unit. This can be very useful if interfacing the amplifier with some OEM source units that do not have conventional turn-on leads.

! IMPORTANT

The sensitivity of the signal sensing turn-on circuit has been designed for high-level (speaker level) signals, not for low-level (preamp level) signals. Using this feature with low-level (preamp level) signals is not recommended. We do not recommend this method of turning the amplifier on and off as a default. Whenever possible, use the conventional remote turn-on lead method. The signal sensing circuit is designed to detect midrange frequency signal presence. If the signal feeding the amplifier is not full-range (for example, if there is an active low-pass crossover in line before the amplifier), this circuit will not operate properly.

To activate the signal sensing turn-on feature, place the “Signal Sensing” switch in the “On” position. This should only be done if there is no conventional turn-on lead connected to the amplifier’s “Remote” connector. When in the “On” position, the signal sensing circuit will monitor the audio input signal and turn the amplifier on when signal is present. After about 25 seconds of no signal, the amplifier will shut off.

Turning on other amplifiers in signal sensing mode: When the signal sensing circuit is turned on, the “Remote” Connector on the amplifier may be used as a remote turn-on source for other amplifiers in the system. +12V will be present at the connector when the amplifier turns on in signal sensing mode and will not be present when the amplifier turns off.

! IMPORTANT

You cannot use the turn-on output to turn on processors that are in the signal path before the 500/1. (Signal will not pass through most processors when they are not powered up, meaning that the amplifier will not turn on until that processor is active).

AMPLIFIER INPUT SECTION

The 500/1 employs a differential-balanced input topology that provides the user with a high degree of input flexibility while retaining superior noise rejection. This type of circuit also allows the 500/1 to accept high-voltage inputs from factory source unit outputs without excessive distortion or noise problems.

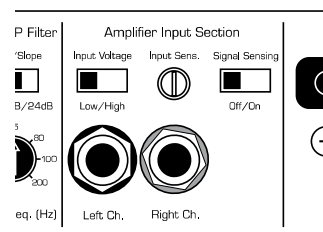

1) **Input Connections:** A standard left/right pair of RCA type jacks is used for input on the 500/1. You may run a stereo or a mono signal into the inputs of the amplifier. The amplifier’s input section automatically sums stereo signals to mono for the internal amplifier section and for the “LP” “Filter Mode” of the “Preamp Output” section.

! IMPORTANT

If you plan to use the “Preamp Output” of the 500/1 to feed a stereo amplifier, you **must** connect a stereo signal to the input of the amplifier. A mono signal into the amplifier will result in a mono signal out of the preamp output. (It’s a great amplifier; but it doesn’t do magic).

The amplifier will operate with only one input connection (left or right), but will require an increase in input sensitivity to overcome the loss of signal. If a mono input signal is to be run, we recommend that you use a “Y-adaptor” to split the mono signal into both inputs of the amplifier.

2) **Input Voltage Range:** A wide range of signal input voltages can be accommodated by the 500/1’s input section (200mV – 8V). This wide range is split up into two sub-ranges, accessible via switches located in the “Amplifier Input Section” of the amplifier.

The “Low” position on the “Input Voltage” switch selects an input sensitivity range between 200mV and 2V. This means that the “Input Sens.” rotary control will operate within that voltage window. If you are using an aftermarket source

unit, with conventional preamp-level outputs, this is most likely the position that you will use.

The “High” position on the “Input Voltage” switch selects an input sensitivity range between 800mV and 8V. This is useful for certain high-output preamp level signals as well as speaker-level output from source units and small amplifiers. To use speaker-level sources, splice the speaker output wires of the source unit or small amplifier onto a pair of RCA cables or plugs.

! IMPORTANT

The output of the amplifier will **decrease** for a given input voltage when the “Input Range” switch is placed in the “High” position. Conversely, the output will be higher with the switch in the “Low” position. While this may sound counter-intuitive, it is consistent with the descriptions above.

3) **Input Sensitivity Adjustment:** Located next to the “Input Voltage” switch, in the “Amplifier Input Section”, is a rotary control labeled “Input Sens.”. Once the appropriate “Input Voltage” range has been selected, this rotary control can be used to match the source unit’s output voltage to the input stage of the amplifier for maximum clean output. Rotating the control clockwise will result in higher sensitivity (louder for a given input voltage). Rotating the control counter-clockwise will result in lower sensitivity (quieter for a given input voltage).

To properly set the amplifier for maximum clean output, please refer to Appendix B (page 14) in this manual. After using this procedure, you can then adjust the level of the amplifier by adjusting the input sensitivity **downward**, if the amplifier requires attenuation to achieve the desired system balance.

Do not increase the “Input Sens.” setting for any amplifier in the system beyond the maximum level established during the procedure outlined in Appendix B (page 14). Doing so will result in audible distortion and possible speaker damage.

CROSSOVER CONTROLS

Crossovers are groups of individual electronic filters which allow only certain frequency ranges to pass through them by attenuating frequencies outside the selected range. These filters allow the user to specify what frequency range will be sent out of each channel section of the amplifier. This, in turn, allows each speaker system to only reproduce a range of frequencies it is well-suited for, resulting in reduced distortion and improved fidelity.

AMPLIFIER LOW-PASS FILTER

The 500/1 employs a sophisticated, state-variable, low-pass active filter for its internal channel. This feature is designed to attenuate frequencies above its filter frequency, so that the system's subwoofers do not reproduce any audible midrange content.

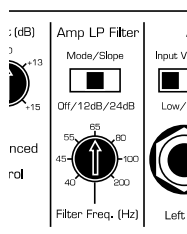

1) Filter Operation: The low-pass filter in the 500/1 is fully variable between 40 Hz and 200 Hz via the “Filter Freq.” control knob and features the ability to select between a moderate “12dB” per octave or a steep “24dB” per octave slope via the “Mode/Slope” switch.

Depending on the subwoofer system and the vehicle, different slopes may be required to produce a smooth transition to the mid-bass speakers in the system. Experiment to find the slope which best matches the acoustic requirements of your system.

Hint: A trunk mounted sub whose output has to “fight” through a rear deck or a back seat often benefits from the 12 dB/octave slope which lets more upper bass content pass through. A sub that fires directly into the listening environment is more likely to benefit from a 24 dB/octave slope.

The above hint is not “set-in-stone”...

You should always listen to the system carefully to determine the best choice as vehicle acoustics and other factors play a big role in choosing the most appropriate filter slope.

2) Precise Frequency Selection: The filter frequency markings on the front panel of the amplifier are for reference purposes and are generally accurate to within 1/3 octave or better. If you would like to select the filter frequency with a higher level of precision, consult Appendix A: Chart A-1 (page 12) of this manual. This chart gives you a more accurate frequency for each of the forty detented positions of the frequency selection control. This method can be very useful if the amplifier is mounted in a location where you can't see the front panel markings easily.

3) Defeating the Amplifier Filter: The Low-Pass filter can also be defeated completely, by switching the “Mode/Slope” switch to the “Off” position. This is useful if you are using an external active crossover in the system. Keep in mind that turning the internal crossover off also defeats the “Advanced Bass Control” section processing (see page 9 for details). With the internal crossover turned off, the 500/1's upper frequency response limit is 250 Hz, due to its bass-specific Class D design.

PREAMP OUTPUT SECTION

The 500/1 incorporates a flexible preamp output section, designed to make multiple amplifier systems easy to set up.

The Preamp output can be configured in three different “Output Modes”:

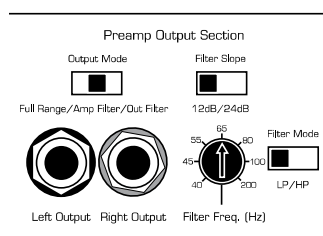

1) “Full-Range”: This is a pass-through mode for the preamp output, delivering the same signal that is being fed to the “Amplifier Input Section” (If the input signal is full-range, the preamp output will be full-range). This signal is not affected by the “Advanced Bass Control” processing selected for the amplifier.

2) “Amp Filter”: The preamp output delivers the same signal that is feeding the 500/1's amplifier section, including all the processing induced by the

“Amp LP Filter” and “Advanced Bass Control” sections. This is primarily used for running additional 500/1's in a “Slave” configuration from the “Master” amplifier. For detailed information on Master/Slave configurations, see Appendix C (page 16). If the “Output Mode” switch is in the “Amp Filter” position and the “Amp LP Filter” switch is in the “Off” position, there will be no output from the preamp output jacks. The independent output filter controls (“Filter Slope”, “Filter Freq” and “Filter Mode”) are inactive in “Amp Filter” mode.

3) “Out Filter”: The preamp output is filtered by a fully variable, active filter incorporated into the output section and is not affected by the bass control processing selected for the amplifier.

- In “Out Filter” mode, the user can select:
- High-pass (“HP”) or low-pass (“LP”) filtering by way of the “Filter Mode” switch.
 - 12 dB/octave or 24 dB/octave filter slope by way of the “Filter Slope” switch.
 - A filter cutoff frequency between 40 - 200 Hz for the preamp output signal by way of the “Filter Control” switch.

This is completely independent of the amplifier's internal filter and allows the user to match, stagger or overlap the subwoofer low-pass filter frequency of the amplifier crossover with the output filter's frequency for precise control and optimized midbass performance.

If you would like to select the filter frequency with a higher level of precision, consult Appendix A: Chart A-2 (page 12) of this manual.

!! CAUTION

The signal level of the “Preamp Output” is affected by the setting of the “Input Voltage Range” switch (of the input section chosen by the “Signal From” switch). See Appendix B (page 14) for details on “Input Voltage” settings. All “slave” amplifiers should get this switch set to “Low”. See Appendix C (page 16) for details.

ADVANCED BASS CONTROL SECTION

The 500/1 includes a versatile bass processing section consisting of two primary components: a fully variable, 24 dB per octave infrasonic filter and a parametric, single-band equalizer.

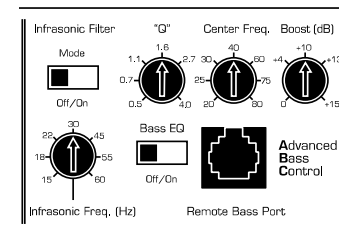

1) “Infrasonic Filter”: The infrasonic filter is a 24 dB/octave high-pass filter; with a fully variable cutoff frequency between 15 - 60 Hz. When set at frequencies lower than 30 Hz, it conserves amplifier power without audibly affecting the quality of the sub-bass output. If set at frequencies higher than 30 Hz, there will be an audible effect, but one which may be desirable for SPL competition purposes or curve shaping of a bottom-heavy system.

With ported enclosures, the use of the infrasonic filter is highly recommended to protect the speaker(s) from excessive excursion below box tuning. With sealed enclosures, the use of the filter is less necessary, but can still help protect the speaker system.

If you would like to select the infrasonic filter frequency with a higher level of precision, consult Appendix A: Chart A-3 (page 13) of this manual.

The infrasonic filter can be completely defeated by selecting the “Off” position on the “Mode” switch. This bypasses all signal from flowing through the circuit.

2) Parametric Bass Equalizer: The parametric equalizer allows the user to select the center frequency of the boost band as well as the bandwidth (“Q”) of the boost band.

The “Q” control selects the bandwidth of the boost around the center frequency. Lower numbers pertain to wider bandwidths while higher numbers pertain to narrower bandwidths.

The “Center Freq.” control selects the center frequency of the boost bandwidth within a range of 20 - 80 Hz. If you would like to select the filter frequency with a higher level of precision, consult Appendix A: Chart A-4 (page 13) of this manual.

The “Boost” control determines how much boost (in dB) you are adding to the bass signal. A range of 0 - 15dB of boost is available.

The “Remote Bass Port” allows the connection of an optional remote boost knob (the RBC-1) that can be mounted in the front of the vehicle. This optional control takes the place of the “Boost” knob on the amplifier when connected and bypasses the “Boost” control on the amplifier.

! IMPORTANT

The “Advanced Bass Control” section will only operate when the amplifier’s filter is activated with the “Amp LP Filter” switch in the “12dB” or “24dB” position. It will not work with this switch in the “Off” position. This is to prevent cascading the processing of multiple amplifiers when configured in a master/slave arrangement as shown in Appendix C (page 16). If you are using an external active crossover and would like to use the “Advanced Bass Control” features, set the “Amp LP Filter” switch on “12dB” and rotate the frequency selection knob fully clockwise to the “200 Hz” position. This will activate the “LF Boost” and “Infrasonic Filter” controls without significantly affecting the crossover point selected by the external active crossover.

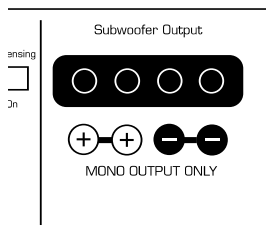

SUBWOOFER OUTPUT

The 500/1 employs JL Audio’s exclusive Regulated, Intelligent Power Supply (R.I.P.S.) design. This sophisticated power supply allows the amplifier to produce its optimum power (500 watts x 1) over a wide range of speaker impedances.

Unlike conventional amplifiers that require a specific impedance to produce optimum power, the R.I.P.S.-equipped 500/1 gives you the freedom to use a variety of subwoofer configurations that

achieve final nominal impedances between 1.5 – 4Ω (without sacrificing power output or sound quality).

The operation of the R.I.P.S. circuitry is entirely automatic and adjusts itself every time the amplifier is turned on according to the lowest impedance present at the speaker load. There are no user controls to configure. The system operates through multiple stages of impedance optimization, choosing the stage most appropriate to the actual impedance of the speaker(s) you connect to it.

! IMPORTANT

If you connect a load higher than 4Ω nominal to the 500/1, power will drop by half with every doubling of impedance above 4Ω. If you connect a load lower than 1.5Ω nominal to the 500/1, the amplifier protection circuitry activates a “safe” mode which reduces amplifier power to protect the circuitry from failure (the yellow LED on the top of the amplifier will light to indicate that this has happened). See page 11 for details.

! IMPORTANT

Speaker loads below 1.5Ω nominal are not recommended and may cause the amplifier output to distort excessively.

Speaker connections to the 500/1 are straightforward and take place at the far right of the front panel. You will notice that there are two “+” positive connections and two “-” negative connections. This is to facilitate multiple speaker wiring. The two positive and two negative connections are connected in parallel inside the amplifier. Connecting two speakers, each to one set of positive and negative terminals, will result in a parallel speaker connection. If only connecting one pair of speaker wires, it is not necessary to use both sets of connections.

Do not chassis ground any speakers connected to this or any other JL Audio amplifier. Doing so will cause the amplifier to go into protection and mute the output.

The 500/1’s speaker connectors are designed to accept 12 AWG – 8 AWG wire.

To connect the speaker wires to the amplifier, first back out the set screws on the top of the

amplifier, using the supplied 2.5 mm hex wrench. Strip 1/2 inch (12 mm) of insulation from each wire and insert the bare wire end into the receptacles on the front panel of the amplifier, seating them firmly so that no bare wire is exposed. While holding each wire in place, tighten each set screw firmly, taking care not to strip the head of the screw and making sure that the wire is firmly gripped by the set screw.

! IMPORTANT

Do **NOT** attempt to “bridge” two 500/1’s or combine their output to a single load in any manner. Doing so will damage the amplifier(s).

! IMPORTANT

Before reconnecting the battery ground and turning the system on, verify that all control settings on the amplifier are set according to the needs of the system.

STATUS INDICATOR LIGHTS / PROTECTION CIRCUITRY

There are three status indicator lights on the top of the amplifier. These are as follows:

1) “Power” (Green): lights to indicate that the amplifier is turned on and operating normally.

2) “Thermal” (Red): lights to indicate that the amplifier has exceeded its safe operating temperature, putting the amplifier into a self-protection mode, which reduces the power output of the amplifier. The red light will shut off and the amplifier will return to normal, full-power operating mode if the heat sink temperature drops back to a safe level.

3) “Low Ω” (Amber): lights to indicate that the impedance of the speaker load connected to the amplifier is lower than the optimum load impedance range for the amplifier. When this light is on, a protection circuit engages and reduces the power output of the amplifier. The amber indicator will also light when a short-circuit is detected in the speaker wiring (this can be a short between the positive and negative speaker wires or between either speaker wire and the vehicle chassis).

There is only one condition that will shut down an undamaged 500/1 completely...

If battery voltage drops below 8 volts, the entire amplifier will shut itself off. The green “Power” indicator on the top of the amplifier will turn off when this occurs. The amplifier will turn back on when voltage climbs back above 9 volts. This may happen in a rapid cycle when bass-heavy program material causes a weak charging system to dip below 8 volts momentarily. If this is happening in your system, have your charging system inspected to make sure it is working properly. A 0.5 or 1.0 Farad rapid-discharge capacitor connected in parallel to the amplifier power connections may minimize these short duration voltage dips in many systems that are having this problem.

For information on troubleshooting this amplifier, refer to Appendix D (page 18).

SERVICING YOUR JL AUDIO AMPLIFIER

If your amplifier fails or malfunctions, please return it to your authorized JL Audio dealer so that it may be sent in to JL Audio for service.

There are no user serviceable parts or fuses inside the amplifier. The unique nature of the circuitry in the JL Audio amplifiers requires specifically trained service personnel. Do not attempt to service the amplifier yourself or through unauthorized repair facilities. This will not only void the warranty, but may result in the creation of more problems within the amplifier.

If you have any questions about the installation or setup of the amplifier not covered in

this manual, please contact your dealer or the **JL AUDIO Technical Department** for assistance:

(954) 443-1100

9:00 AM – 5:30 PM Eastern Time,

Monday – Friday

APPENDIX A:

Precise Frequency Selection

**CHART A-1
AMPLIFIER LOW-PASS FILTER**

Detent Number	Panel Marking	Actual Freq.
Full counter-clockwise: 42		
01		.42
02		.42
03		.42
04	"40"	.42
05		.43
06		.44
07		.46
08	"45"	.47
09		.49
10		.50
11		.52
12		.53
13		.55
14	"55"	.57
15		.58
16		.60
17		.63
18		.65
19	"65"	.67
20		.70
21		.73
22		.76
23		.79
24	"80"	.83
25		.87
26		.92
27		.96
28		1.02
29	"100"	1.08
30		1.14
31		1.22
32		1.31
33		1.43
34		1.57
35		1.84
36	"200"	1.93
37		1.98
38		1.98
39		1.98
Full-clockwise : 198		

**CHART A-2
PREAMP AMP FILTER**

Detent Number	Panel Marking	Actual Freq.
Full counter-clockwise: 41		
01		.41
02		.41
03		.41
04	"40"	.42
05		.42
06		.43
07		.44
08	"45"	.45
09		.47
10		.48
11		.49
12		.51
13		.53
14	"55"	.54
15		.56
16		.58
17		.60
18		.62
19	"65"	.64
20		.67
21		.69
22		.72
23		.75
24	"80"	.78
25		.82
26		.86
27		.90
28		.95
29	"100"	1.00
30		1.07
31		1.13
32		1.22
33		1.31
34		1.43
35		1.56
36	"200"	1.69
37		1.86
38		1.92
39		1.97
Full-clockwise : 197		

**CHART A-3
INFRASONIC FILTER**

Detent Number	Panel Marking	Actual Freq.
Full counter-clockwise: 14		
01		.14
02		.14
03		.14
04	"15"	.14
05		.15
06		.15
07		.16
08	"18"	.17
09		.17
10		.18
11		.19
12		.20
13		.20
14	"25"	.21
15		.22
16		.24
17		.25
18		.27
19		.28
20	"30"	.30
21		.33
22		.35
23		.39
24		.42
25	"40"	.47
26		.50
27		.51
28		.54
29		.56
30		.56
31	"50"	.57
32		.58
33		.58
34		.58
35		.59
36	"60"	.60
37		.61
38		.61
39		.61
Full-clockwise : 61		

**CHART A-4
EQ CENTER FREQUENCY**

Detent Number	Panel Marking	Actual Freq.
Full counter-clockwise: 22		
01		.22
02		.22
03		.22
04	"20"	.22
05		.22
06		.24
07		.24
08	"25"	.25
09		.26
10		.27
11		.28
12		.30
13		.31
14	"30"	.32
15		.34
16		.35
17		.38
18		.40
19	"40"	.42
20		.45
21		.48
22		.51
23		.56
24	"60"	.61
25		.67
26		.69
27		.72
28		.75
29	"75"	.76
30		.77
31		.77
32		.78
33		.79
34		.80
35		.81
36	"80"	.81
37		.81
38		.81
39		.81
Full-clockwise : 81		

APPENDIX B:

Input Sensitivity Level Setting

JL Audio amplifiers utilizing the Regulated Intelligent Power Supply (R.I.P.S.) allow delivery of their rated power when connected to any load impedance from 1.5 - 4Ω per channel and when connected to a charging system with any voltage from 11 - 14.5V. This design is beneficial for many reasons. One of these reasons is ease of setup. Because each JL Audio amplifier will always deliver the same amount of power within its operational range of impedances and supply voltages, the maximum, unclipped output is very predictable. This makes setting the gain structure via the input sensitivity controls very simple. Following the directions below will allow the user to adjust the input sensitivity of the amplifier(s) simply and easily in just a few minutes using equipment which is commonly available in installation bays.

Necessary Equipment

- Digital AC Voltmeter
- CD with a sine-wave test tone recorded at 0 dB reference level in the frequency range to be amplified (ex. 50 Hz for a subwoofer amplifier; 1 kHz for a midrange application). Do not use attenuated test tones (-10 dB, -20 dB, etc.).

The Nine-Step Procedure

- 1) Disconnect the speaker(s) from the amplifier's "Subwoofer Output" connectors (you only need to remove the negative or positive speaker wire).
- 2) Turn "Off" all processing on the source unit and amplifier (bass/treble, loudness, EQ, etc.).
- 3) Switch the "Input Voltage" to "Low" and turn the "Input Sens." control on the amplifier all the way down.
- 4) Set the source unit volume to 3/4 of full volume. If the amplifier is being driven by a source unit's dedicated subwoofer output, also adjust the source unit's subwoofer level control to 3/4 of maximum output. This will allow for reasonable gain overlap with moderate clipping at full volume.

- 5) Using the chart below, determine the target voltage for input sensitivity adjustment according to the nominal impedance of the speaker system connected to the amplifier output.

Nom. Impedance	Target AC Voltage
4Ω (or higher)	44.7 V
3Ω	38.7 V
2Ω	31.6 V
1.5Ω	27.4 V

- 6) Verify that you have disconnected the speakers before proceeding. Play a track with an appropriate sine wave (within the frequency range to be amplified) at 3/4 source unit volume.

- 7) Connect the AC voltmeter to the "Subwoofer Output" connectors of the amplifier:

- 8) Increase the "Input Sens." control until the target voltage is delivered. If multiple subwoofer amps are being used, set each one to the same exact voltage and you have also level matched them. If excessive voltage is read with the control at minimum (full counterclockwise), switch the "Input Voltage" to "High" and re-adjust.

- 9) Once you have adjusted each amplifier to its maximum unclipped output level, reconnect the speaker(s). The "Input Sens." can now be adjusted downward if the amplifier requires attenuation to achieve the desired system balance.

! IMPORTANT

Do not increase any "Input Sens." setting in the system beyond the maximum level established during this procedure. Doing so will result in audible distortion and possible speaker damage.

APPENDIX C:

Master/Slave Configurations

With the flexible on-board crossovers and processing incorporated into the 500/1, it is possible to connect multiple 500/1's in a "Master/Slave" configuration, with each amplifier driving its own speaker system but controlled by the processing and filtering of only one amplifier. This is very useful when driving multiple subwoofers with multiple amplifiers.

To create a Master/Slave configuration, first determine which amplifier will be the "Master" amplifier and connect the main input signal to that amplifier (from the source unit or from an outboard processor). This amplifier's "Amp LP Filter" section and "Advanced Bass Control" features will process the signal for the "Slave" amplifier or amplifiers.

Here is the procedure for implementing a "Master/Slave" configuration:

1) Set the "Master" amplifier's "Output Mode" switch to the center "Amp Filter" position. This will send a parallel, mono-summed signal from the "Master" amplifier's "Amp LP Filter" section to its preamp outputs.

2) Connect an RCA cable from the "Master" amplifier's preamp outputs to the main input of the first "Slave" amplifier. Set the "Slave" amplifier's "Amp LP Filter" to the "Off" position. This will defeat the LP filter and the bass processing of this "Slave Amplifier".

3) The input sensitivity of the two amplifiers needs to be adjusted independently. To properly calibrate the amplifiers for maximum, identical, clean output, please refer to Appendix B (page 14). After using this procedure, you can then adjust the level of the amplifiers by adjusting the input sensitivities downward, if the amplifiers require attenuation to achieve the desired system balance. If the input sensitivities are adjusted, the amplifiers must be recalibrated to ensure identical power output levels.

Please note that the "Input Range" switch on all "slave" amplifiers needs to be set to "Low", even if the "master" amplifier is high voltage and its switch is set to "High". All signals passed

out of the preamp outputs of the amplifier are compatible with the "Low" setting on the "Input Range" control.

The "Signal Sensing" turn-on feature will not work on "slave" amplifiers, but "slave" amplifiers can be turned on and off by a "master" amplifier operating in signal sensing turn-on mode. Simply connect the "master" amplifier's "Remote" connection, to the "slave" amplifier(s) "Remote" connection(s).

Do not increase the "Input Sens." setting for any amplifier in the system beyond the maximum level established during the procedure outlined in Appendix B (page 14). Doing so will result in audible distortion and possible speaker damage.

4) If you would like to run a third amplifier in "Slave" configuration, select the "Full-Range" position on the "Output Mode" switch of the first "Slave" amplifier. Then, connect an RCA cable from the first "Slave" amplifier's preamp outputs to the second "Slave" amplifier. As you did with the

first "Slave" amplifier, set the second "Slave" amplifier's "Amp LP Filter" to the "Off" position. Then, calibrate the third amplifier's "Input Range" and "Input Sens." controls in the same manner as you did for the second amplifier.

Additional amplifiers may be added to this "Master/Slave" configuration following the same procedure as in step 4.

Once you match the input sensitivities of all the amplifiers, you can use the "Master" amplifier's "Amp LP Filter" and "Advanced Bass Control" features to control the "Slave" amplifier(s). If the remote bass control (RBC-1) is used, it need only be connected to the "Master" amplifier to control all the amplifiers in the Master/Slave chain.

Below is a diagram showing a Master/Slave configuration with one "Master" (top amplifier) and two "Slave" amplifiers. Switches and controls that are defeated in the "Slave" amplifiers are printed in gray.

The Master amplifier's "Advanced Bass Control" section is active and affects all three amplifiers equally.

This Slave amplifier's "Advanced Bass Control" section and AMP LP Filter are inactive, but the Full-Range (pass-through) feature of its "Preamp Output" feeds the input of the next Slave amplifier.

The last Slave amplifier's "Advanced Bass Control" section, AMP LP Filter and "Preamp Output" are inactive.

MASTER:

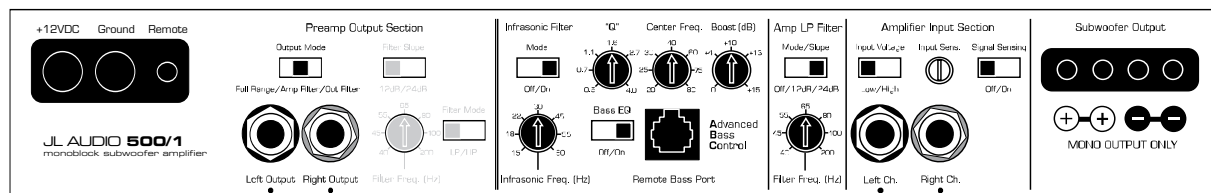

SLAVE (A):

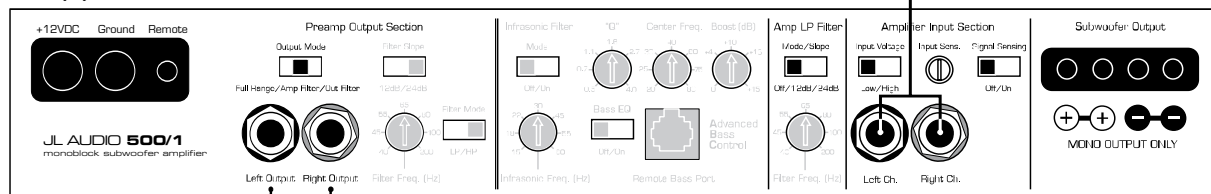

SLAVE (B):

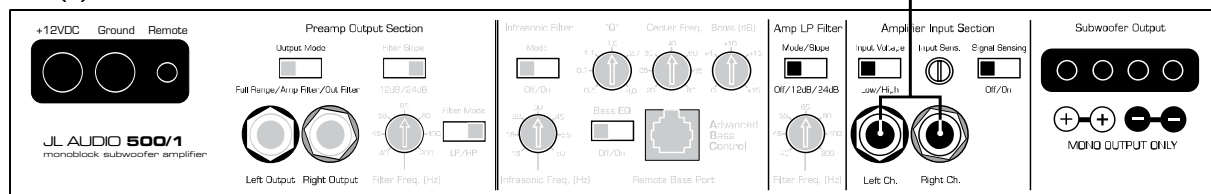

“MY AMPLIFIER DOESN’T TURN ON”

- Check** to make sure there is +12V at the “Remote” connection of the amplifier. In some cases, the turn-on lead from the source unit is insufficient to turn on multiple devices and the use of a relay is required. To test for this problem, jump the “+12V” wire to the “Remote” terminal to see if the amplifier turns on. If this does not work, proceed to the next step.
- Check** the fuse, not just visually but with a continuity meter. It is possible for a fuse to have poor internal connections that cannot be found by visual inspection. It is best to take the fuse out of the holder for testing. If no problem is found with the fuse, inspect the fuse-holder.
- Check** the “Signal Sensing” switch to make sure it is in the desired position. If you are using a remote wire, this switch should be in the “Off” position. If you are using the signal sensing feature, make sure there is a full-range signal being sent to the RCA inputs of the amplifier. If you continue to have trouble with the signal sensing feature, test the amplifier’s ability to turn on by throwing the “Signal Sensing” switch to the “Off” position and jumping the “+12V” wire to the “Remote” terminal. If this turns the amplifier on, check your input signal and connections.

“I GET A DISTORTED / ATTENUATED SOUND COMING OUT OF THE SPEAKER(S)”

- Check** the speaker wires for a possible short, either between the positive and negative or between a speaker lead and the vehicle’s chassis ground. If a short is present you will experience distorted and/or attenuated output. The “Low Ω ” light may also illuminate in this situation. It may be helpful to disconnect the speaker wires from the amplifier and use a different set of wires connected to a test speaker.
- Check** the nominal load impedance to verify that the amplifier is driving a load between 1.5 - 4 Ω . JL Audio monoblock amplifiers have two “+” positive connections and two “-” negative connections. This is to facilitate multiple speaker wiring. The two positive and two negative connections are connected in parallel inside the amplifier. Connecting two speakers, each to one set of positive and negative terminals, will result in a parallel speaker connection. In this case, each of the two loads should have a nominal impedance between 3 - 8 Ω .
- Check** the input signal and input signal cables to make sure signal is present at the “Amplifier Input Section” and the cables are not pinched or loose. It may be helpful to try a different set of cables and/or a different signal source to be sure.

“MY AMPLIFIER SHUTS OFF ONCE IN A WHILE, USUALLY AT HIGHER VOLUMES”

- Check** your voltage source and grounding point. The R.I.P.S. power supply is rated to operate with source voltages between 11 - 14.5V. Shutdown problems at higher levels can occur when the charging system voltage drops below 10-volts. These dips can be of very short duration making them extremely difficult to detect with a common DC voltmeter. To ensure proper voltage, inspect all wiring and termination points. It is also a good idea to improve the vehicle’s factory ground wire and termination point. Grounding problems are the leading cause of mis-diagnosed amplifier failures.

“MY AMPLIFIER TURNS ON, BUT THERE IS NO OUTPUT”

- Check** the input signal using an AC voltmeter to measure the voltage from the source unit while an appropriate test tone is played through the source unit (disconnect the RCA cables from the amplifier prior to this test). The frequency used should be in the range that is to be amplified by the channels being tested (example: 50 Hz for a sub bass amplifier channel and 1 kHz for a full-range amplifier channel). A steady voltage should be present at the output of the RCA cables. If you are receiving a sufficient voltage (between 0.2 and 8.0-volts), check to ensure that the speaker wires are making a good connection with the metal inside the amplifier. The connectors are designed to accept up to an 8 AWG wire. If you are using significantly smaller wire (14 AWG or smaller), you may have difficulty making an adequate connection. In this case, you may find it necessary to “fold” the wire over once (or twice!) so as to make a solid connection. Make sure to strip the wire to allow for a sufficient connection with the input or output of the amplifier.
- Check** the output of the amplifier. Using the procedure explained in the previous check item (after plugging the RCA cables back into the amplifier) test for output at the speaker outputs of the amplifier. Unless you enjoy test tones at high levels, it is a good idea to remove the speaker wires from the amplifier while doing this. Turn the volume up approximately half way. 5-volts or more should be measured at the speaker outputs. This output level can vary greatly between amplifiers but it should not be in the millivolt range with the source unit at half volume. If you are reading sufficient voltage, check your speaker connections as explained above.

APPENDIX D: TROUBLE SHOOTING (CONT.)

“MY AMPLIFIER’S OUTPUT FLUCTUATES WHEN I TAP ON IT OR HIT A BUMP”

Check the connections to the amplifier. Make sure that the insulation for all wires has been stripped back far enough to allow a good contact area inside the amplifier terminal.

Check the RCA connectors to ensure that both the center pin and the outer shield are making good contact with the input jacks on the amplifier.

“HOW DO I PROPERLY SET THE INPUT SENSITIVITY ON MY AMPLIFIER”

Please refer to Appendix B (page 14) to set the input sensitivity for maximum, unclipped output.

APPENDIX E: 500/1 Specifications

GENERAL SPECIFICATIONS:

Recommended Fuse Value: 50A

Recommended Fuse Type: AGU or MaxiFuse™

INPUT SECTION:

Input Type: Differential-balanced with RCA jack inputs

Input Range: Switchable from 200mV - 2V RMS to 800mV - 8V RMS

AMPLIFIER SECTION:

Amplifier Topology: H-Bridge, Class D Mono with impedance optimization and patented discrete drive circuitry

Power Supply: Pulse width modulation-regulated switching power supply

Rated Power: 500W RMS x 1 @ 1.5 - 4Ω (11 - 14.5V)

THD at Rated Power: <0.05% @ 4Ω, 50 Hz

Signal to Noise Ratio: >95 dB referred to rated power (A-weighted, 20 Hz - 20 kHz noise bandwidth)

Frequency Response: 5 - 250 Hz (+0, -3 dB)

Damping Factor: >500 @ 4Ω/50 Hz, >250 @ 2Ω/50 Hz

CROSSOVER SECTION:

Amplifier Low-Pass Filter: State-variable, 12 dB/octave Butterworth or 24 dB/octave Linkwitz-Riley with continuously variable cutoff frequency selection from 40 - 200 Hz, defeatable

PREAMP OUTPUT:

2-Channel, with fully independent, state-variable, 12 dB/octave Butterworth or 24 dB/octave Linkwitz-Riley filter with continuously variable cutoff frequency selection from 40 - 200 Hz, defeatable

ADVANCED BASS CONTROL SECTION:

Parametric EQ: Single-band, fully parametric equalizer with “Q” adjustment from 0.5 - 4.0, center frequency adjustment from 20 - 80 Hz, boost adjustment from 0 to +15dB and port for optional remote bass boost control (RBC-1), defeatable

Infrasonic Filter: Fully variable, 24 dB/octave Butterworth high-pass filter; cutoff frequency adjustable from 15 - 60 Hz, defeatable

DIMENSIONS: (LxWxH):

13.4" x 9.25" x 2.36" (340mm x 235mm x 60mm)

Due to ongoing product development, all specifications are subject to change without notice.

INSTALLATION NOTES:

Use this diagram to document your amplifier's switch and control positions.

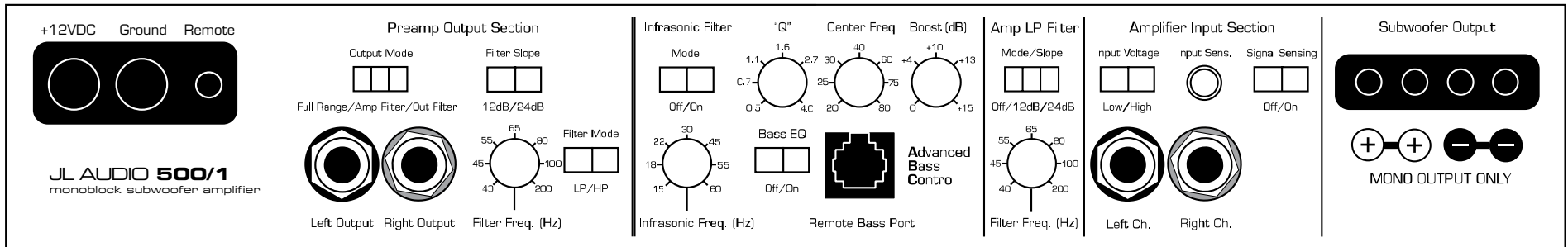

LIMITED WARRANTY - AMPLIFIERS (USA)

JL AUDIO warrants this product to be free of defects in materials and workmanship for a period of ninety (90) days from the original date of purchase. The warranty term is extended to two (2) years if installation is performed or approved by an authorized JL AUDIO dealer (proof of installation or approval required on purchase receipt).

This warranty is not transferrable and applies only to the original purchaser from an authorized JL AUDIO dealer. Should service be necessary under this warranty for any reason due to manufacturing defect or malfunction, JL AUDIO will (at its discretion), repair or replace the defective product with new or remanufactured product at no charge. Damage caused by the following is not covered under warranty: accident, misuse, abuse, product modification or neglect, failure to follow installation instructions, unauthorized repair attempts, misrepresentations by the seller. This warranty does not cover incidental or consequential damages and does not cover the cost of removing or reinstalling the unit(s). Cosmetic damage due to accident or normal wear and tear is not covered under warranty.

Warranty is void if the product's serial number has been removed or defaced.

Any applicable implied warranties are limited in duration to the period of the express warranty as provided herein beginning with the date of the original purchase at retail, and no warranties, whether express or implied, shall apply to this product thereafter. Some states do not allow limitations on implied warranties, therefore these exclusions may not apply to you. This warranty gives you specific legal rights, and you may also have other rights which vary from state to state.

If you need service on your JL AUDIO product:

All warranty returns should be sent to JL AUDIO 's Amplifier Service Facility freight-prepaid through an authorized JL AUDIO dealer and must be accompanied by proof of purchase (a copy of the original sales receipt). Direct returns from consumers or non-authorized dealers will be refused unless specifically authorized by JL AUDIO with a valid return authorization number.

Warranty expiration on products returned without proof of purchase will be determined from the manufacturing date code. Coverage may be invalidated as this date is previous to purchase date. Non-defective items received will be returned freight-collect. Customer is responsible for shipping charges and insurance in sending the product to JL AUDIO. Freight damage on returns is not covered under warranty.

For Service Information in the U.S.A. please call:

JL Audio customer service: (954) 443-1100

during normal business hours (9:00 AM – 5:30 PM Eastern Time)

JL Audio, Inc

10369 North Commerce Pkwy.

Miramar, FL 33025

(do not send product for repair to this address)

International Warranties:

Products purchased outside the United States of America are covered only by that country's distributor and not by JL Audio, Inc.

Patented Class D Amplifier Circuit (U.S. Patent #6,441,685) is Patent-Pending in the following countries: Austria, Belgium, Brazil, Canada, China, France, Germany, Indonesia, Italy, Japan, Republic of Korea, Mexico, Netherlands, Norway, Russian Federation, Singapore, Sweden, Switzerland, United Kingdom, and all other PCT countries.